



STKR
INTERNATIONAL

**Manufacturer & Exporter of
ORTHOPEDIC INSTRUMENTS**



www.stkrsurgical.com

Bone Cutting Forceps

McIndoe Bone Cutting Forcep

Lightweight, compound action, angled jaw with prismatic points

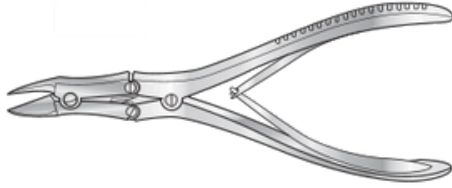

Code	TI-	DeTription
OR/13b		165mm long
TI-OR/13c		191mm long

Liston Box Joint Bone Cutting Forcep

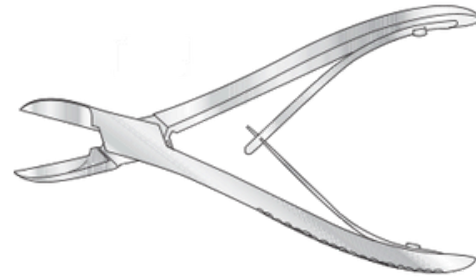

Code	TI-	DeTription
OR/032		140mm long
TI-OR/033		200mm long
TI-OR/027		220mm long

Code	TI-	DeTription
OR/061		170mm long
TI-OR/062		220mm long

Liston Trew Joint Bone Cutting Forcep

With fluted handle

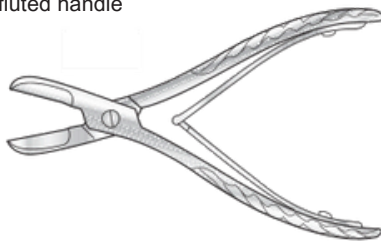

Code	DeTription
TI-OR/24	Straight
TI-OR/24a	Angled

Code	DeTription
TI-OR/26	Straight

Code	DeTription
TI-OR/25	Straight
TI-OR/25a	Angled

Code	DeTription
TI-OR/27	Straight

Tirew Joint Bone Cutting Forcep

Straight



Code	DeTription
TI-OR/030	160mm long

Liston Compound Action Bone Cutting Forcep

Straight, for heavy duty

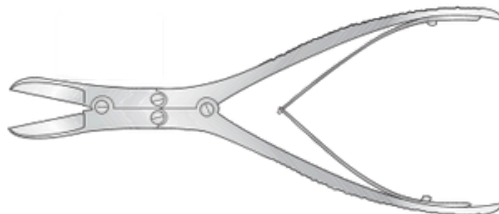

Code	DeTription
TI-OR/27a	305mm long
TI-OR/27b	300mm long
TI-OR/27c	190mm long

Ruskin-Liston Bone Cutting Forcep

Compound action, fine

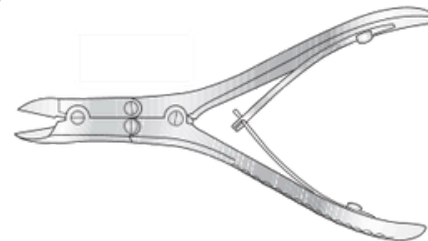

Code	DeTription
TI-OR/057	140mm long
TI-OR/074	145mm long
TI-OR/073	190mm long

Code	DeTription
TI-OR/063	190mm long

Ward Bone Cutting Forceps

Slightly angled on flat

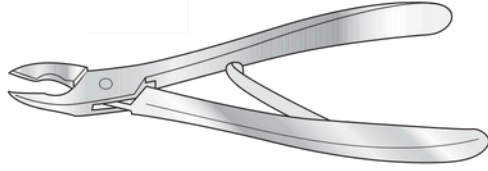

Code	DeTription
TI-GI/459	180mm long

Kleinert Kutz Bone Rongeur

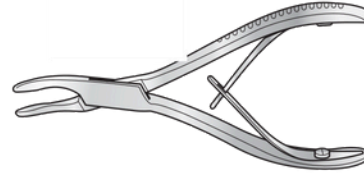

Code	TI-	DeTription
OR/009a		Curved, 140mm, width 2mm
TI-OR/009		Curved, 155mm, width 2mm
TI-OR/011		Curved, 155mm, width 3mm

Horsley Compound Action Bone Cutter



Code	DeTription
TI-OR/002	235mm long

Kleinert Kutz Skin Hooks



Code	TI-	DeTription
PL/109		16cm large
TI-PL/108		16cm medium
TI-PL/107		16cm small

Stamms Box Joint Bone Cutter

Standard, stainless steel

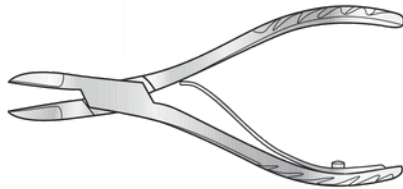

Code	DeTription
TI-OR/N056	140mm long

Bone Rongeurs

Echlin Compound Action Bone Rongeur

Straight, with or without horn, 230mm long

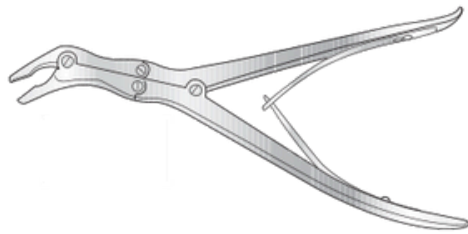

Code	TI-	DeTription
OR/005		Width 2mm
TI-OR/006		Width 3mm
TI-OR/007		Width 4mm



Stille Compound Action Bone Rongeur

Angled to side, 240mm long

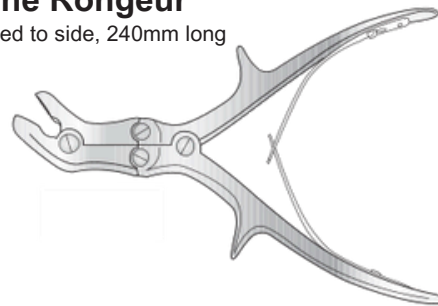

Code	DeTription
TI-OR/037	11mm bite



Leksell Compound Action Bone Rongeur

250mm long

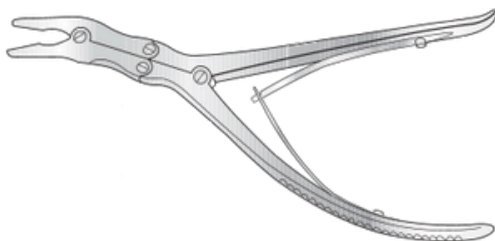

Code	TI-	DeTription
OR/066		3mm bite
TI-OR/069		5mm bite
TI-OR/065		8mm bite

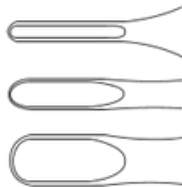

Leksell Stille Compound Action Bone Rongeur

240mm long

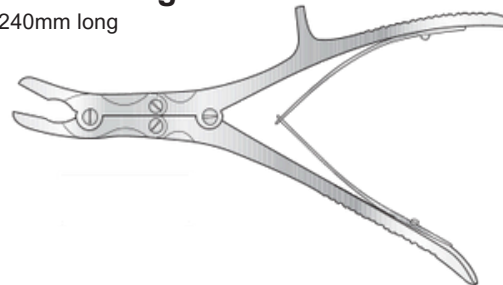

Code	DeTription
TI-OR/065a	8mm bite



Leksell Compound Action Bone Rongeur

240mm long

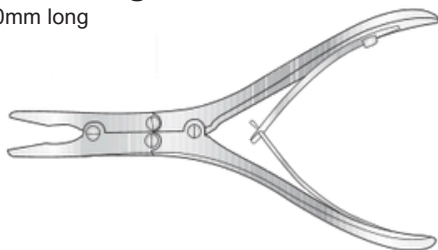

Code	DeTription
TI-OR/008	Width 3mm



Luer Stille Compound Action Bone Rongeur

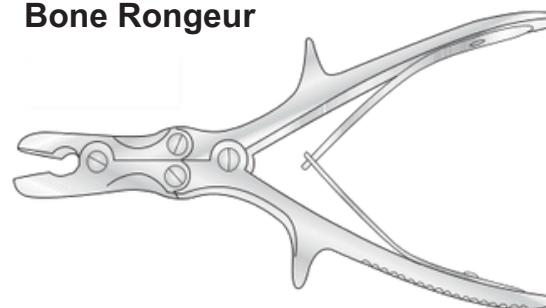

Straight

Code	TI-	DeTription
OR/071		220mm long 12mm bite,
TI-OR/072		260mm long

Curved

Code	TI-	DeTription
OR/071a		220mm long 11mm bite,
TI-OR/071b		230mm long



Luer Compound Action Bone Rongeur

6mm bite, 190mm long

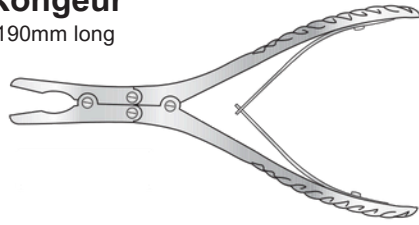

Code	DeTription
TI-OR/13	Straight
TI-OR/13a	Curved

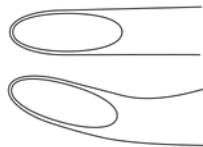

Ruskin Compound Action Bone Rongeur

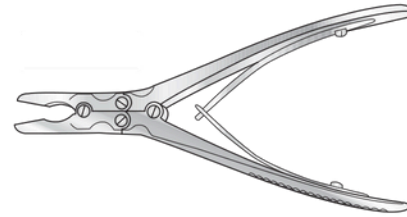

3mm bite, 150mm long

Code	TI-	DeTription
OR/034		Straight
TI-OR/035		Curved

4mm bite, 185mm long

Code	TI-	DeTription
OR/028		Straight
TI-OR/036		Curved

Luer Box Joint Bone Rongeur

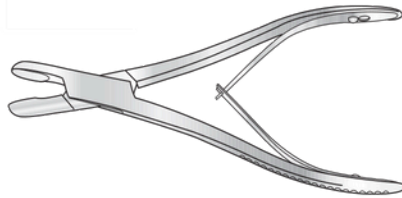

Straight, 185mm long

Code	TI-	DeTription
OR/031		8mm bite
TI-OR/041		10mm bite

Curved, 210mm long

Code	DeTription
TI-OR/042	8mm bite

Compound Action Bone Rongeur

Lightweight pattern, curved, 150mm long

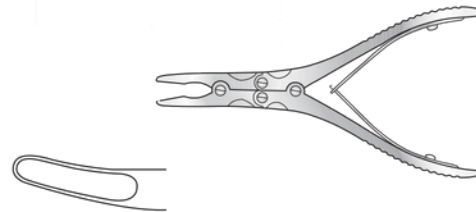

Code	DeTription
TI-OR/013d	4mm bite

Cushing Tlrew Joint Bone Rongeur

190mm long

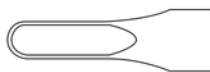

Straight

Code	TI-	DeTription
OR/039		4mm bite
TI-OR/058		6mm bite
TI-OR/059		8mm bite

Curved

Code	TI-	DeTription
OR/060		4mm bite
TI-OR/067		6mm bite
TI-OR/068		8mm bite

Lempert Box Joint Bone Rongeur

3mm bite, 155mm long



Code	TI-	DeTription
OR/327		Straight
TI-OR/010		Curved

Bone Holding Forceps

Lambotte Bone Holding Forceps

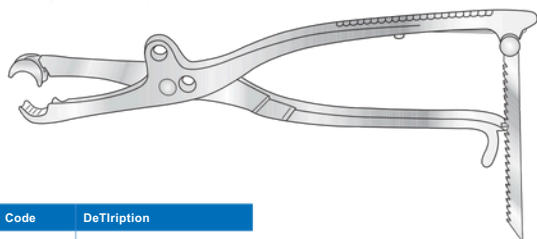

Code	DeTription
TI-OR/015	265mm long

Bone Holding Forceps

Tirew joint, with holding Tlrew

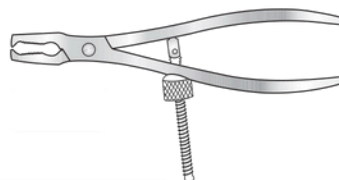

Code	DeTription
TI-OR/029	165mm long

Lambotte Bone Holding Forceps

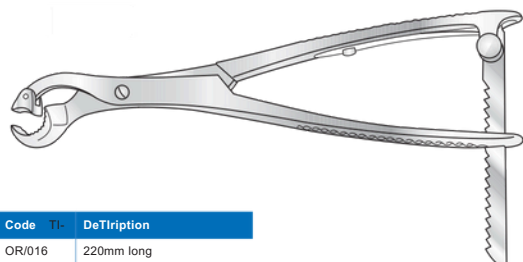

Code	Tl-	DeTription
OR/016		220mm long
TI-OR/017		215mm long
TI-OR/022		330mm long

Hey Groves Bone Holding Forceps

With Tlrew locking device



Code	Tl-	DeTription
OR/29d		200mm long
TI-OR/29e		225mm long
TI-OR/29f		305mm long

Farabeuf Bone Holding Forceps



Code	Tl-	DeTription
OR/021		230mm long
TI-OR/328		250mm long

Bone Holding Forceps



Code	Tl-	DeTription
OR/13	TI-	140mm long
OR/014		185mm long
TI-OR/018		215mm long
TI-OR/019		275mm long

Farabeuf-Lambotte Bone Holding Forceps

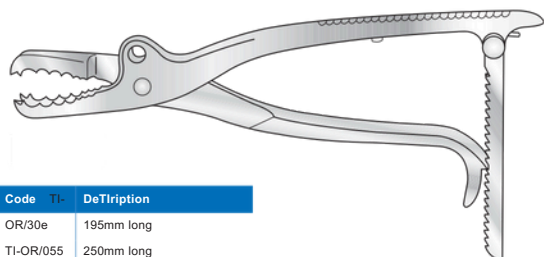

Code	Tl-	DeTription
OR/30e		195mm long
TI-OR/055		250mm long
TI-OR/30f		260mm long

Fergusson Bone Holding Forceps



Code	Tl-	DeTription
OR/30	TI-	150mm long
OR/30a		200mm long
TI-OR/30b		230mm long

Sequestrum (Necrosis) Forcep

Straight, long fine jaws

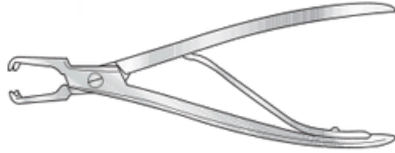

Code	DeTription
TI-OR/N061	180mm long



Code	TI-	DeTription
OR/SEQ001		191mm
TI-OR/SEQ002		long
		203mm
		long

Joint Calcaneal Spreader

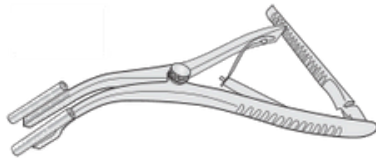

Code	DeTription
TI-OR/CAL001	40mm opening, 1.6mm ø, 170mm long

Calcaneal Spreader

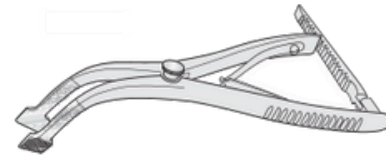

Code	DeTription
TI-OR/CAL002	40mm opening, 15mm wide tip, 70mm long

Inge Type Lamina Spreader

18-US\$

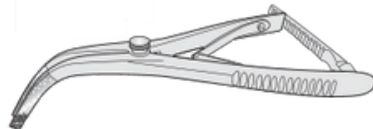

Code	DeTription
TI-OR/CAL003	40mm opening, no teeth, 5mm wide tip, 170mm long

Inge Type Lamina Spreader

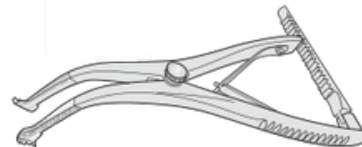

Code	DeTription
TI-OR/CAL004	Baby, 40mm opening, with teeth, 10mm wide tip, 160mm long
TI-OR/CAL004a	50mm opening, with teeth, 10mm wide tip, 240mm long

Harrison Bone Holding Forceps



Code	DeTription
TI-OR/30d	190mm long

St Thomas Bone Holding Forceps



Code	DeTription
TI-OR/403c	182mm long

Bone Holding Forceps and Clamps

Burns Bone Holding Forceps

Box joint

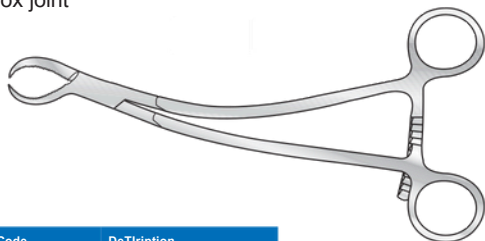

Code	DeTRIPTION
TI-OR/29a	200mm long

Tiarf Type Clamp

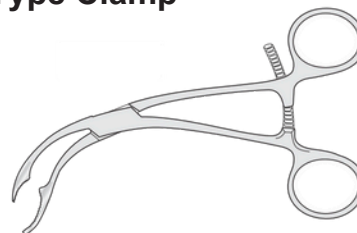

Code	DeTRIPTION
TI-OR/TIA	150mm long

Or thopaedic Grasping Forceps

Box joint

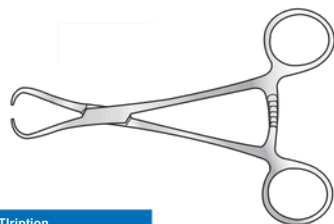

Code	TI-	DeTRIPTION
OR/29b		125mm long
TI-OR/29c		165mm long

Lowman Bone Holding Clamp

Infant 125mm long Child 175mm long Adult 205mm long

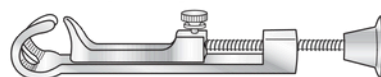

Code
TI-OR/28

Reduction Forcep

With adjustable lock



Code	TI-	DeTRIPTION
OR/RED001a		Small, 135mm long
TI-OR/RED001b		Large, 168mm long

Parker Modified Lowman Bone Holding Clamp, Single

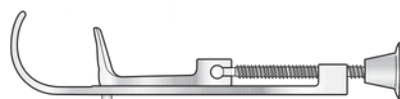

Code	DeTRIPTION
TI-OR/5644	160mm long

Verbrugge Bone Holding Forceps

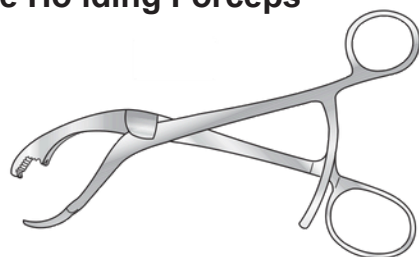

Code	DeTRIPTION
TI-OR/30c	180mm long

Parker Retractor

For use with Lowman clamp

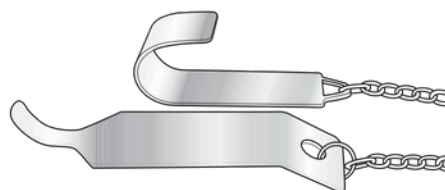

Code	DeTRIPTION
TI-OR/5643	Chain 850mm long

Haglund Plaster Spreader

Working part curved in right

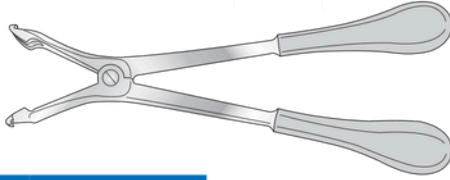

Code	DeTriage
TI-OR/207	280mm long

Plaster Cutter

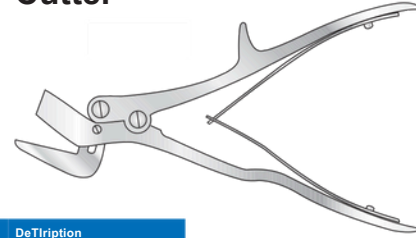

Code	DeTriage
TI-OR/40	240mm long

Lawton Plaster Spreader

Working part curved in right

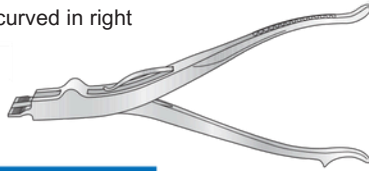

Code	DeTriage
TI-OR/208	220mm long

Bohler Plaster Shears



Code	DeTriage
TI-OR/38	240mm long

Henning Plaster Spreader



Code	DeTriage
TI-OR/211	270mm long

Guys Plaster Shears



Code	DeTriage
TI-OR/39	240mm long

Wolf Plaster Spreader

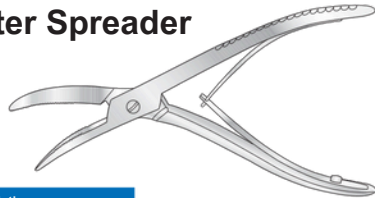

Code	DeTriage
TI-OR/212	180mm long
TI-OR/329	250mm long

Engel Plaster Saw



Code	DeTriage
TI-OR/40b	150mm long

Stille Type Plaster Shears



Code	DeTriage
TI-OR/210	380mm long
TI-OR/210a	330mm long
TI-OR/210b	460mm long

Eccentric Plaster Shears

Without heavy serrated blade

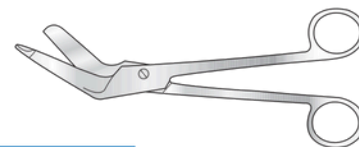

Code	DeTriage
TI-OR/40a	190mm long

Bone Curettes

Bone Curette

Straight, 180mm long

Code	Ti-	DeTription	Code	Ti-	DeTription
OR/075		Width 2mm	OR/079		Width 10mm
TI-OR/076		Width 4mm	TI-OR/080		Width 12mm
TI-OR/077		Width 6mm	TI-OR/081		Width 14mm
TI-OR/078		Width 8mm	TI-OR/082		Width 16mm

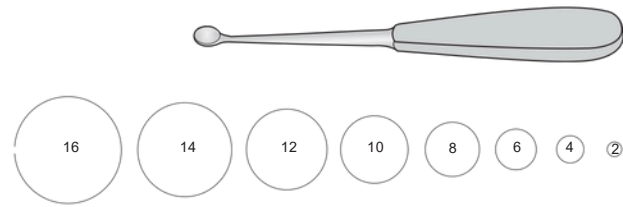

Bone Curette

Straight, 260mm long

Code	Ti-	DeTription	Code	Ti-	DeTription
OR/083		Width 2mm	OR/086		Width 8mm
TI-OR/084		Width 4mm	TI-OR/087		Width 10mm
TI-OR/085		Width 6mm	TI-OR/088		Width 12mm

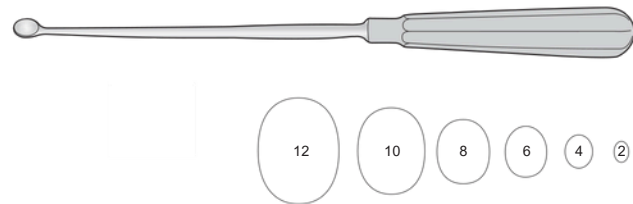

Bone Curette

Straight, 210mm long

Code	Ti-	DeTription
OR/089		Width 2mm
TI-OR/090		Width 4mm
TI-OR/091		Width 6mm
TI-OR/092		Width 8mm
TI-OR/093		Width 10mm
TI-OR/094		Width 12mm
TI-OR/095		Width 14mm
TI-OR/096		Width 16mm
TI-OR/097		Width 20mm

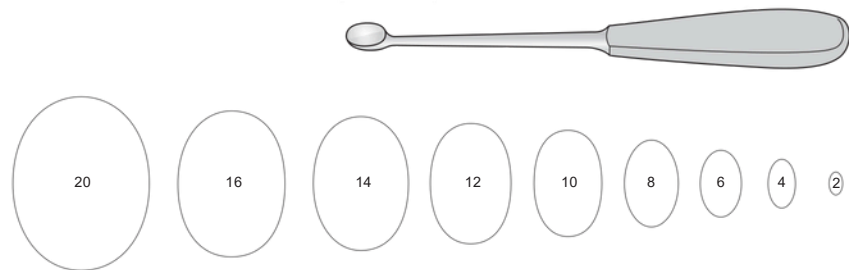

BuThe Bone Curette

Angled, 250mm long

Code	Ti-	DeTription
OR/138		Width 3mm
TI-OR/139		Width 4mm
TI-OR/140		Width 5mm

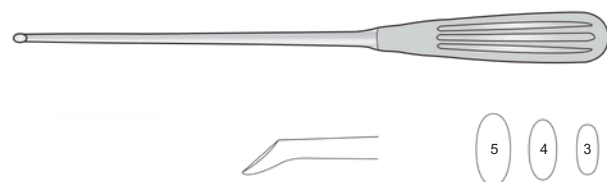

Bruns Bone Curette

225mm long
Straight

Code	Ti-	DeTription	Code	Ti-	DeTription
OR/189		Width 3mm	OR/195		Width 3mm
TI-OR/190		Width 4mm	TI-OR/196		Width 4mm
TI-OR/191		Width 5mm	TI-OR/197		Width 5mm
TI-OR/192		Width 6mm	TI-OR/198		Width 6mm
TI-OR/193		Width 7mm	TI-OR/199		Width 7mm
TI-OR/194		Width 8mm	TI-OR/200		Width 8mm

Angled

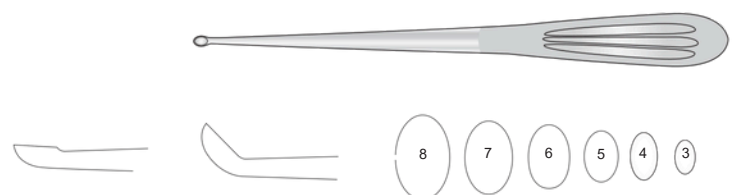

Gourdet Bone Curette

Straight, blunt
280mm long

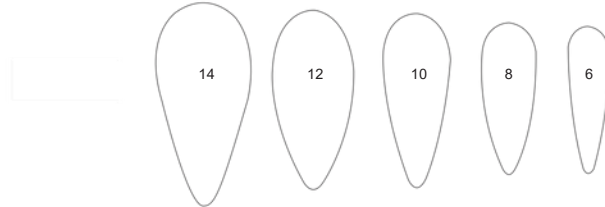

Code	DeTscription
TI-OR/157	Width 6mm
TI-OR/158	Width 8mm
TI-OR/159	Width 10mm
TI-OR/160	Width 12mm
TI-OR/161	Width 14mm

Shroeder Bone Curette

Straight, 310mm long

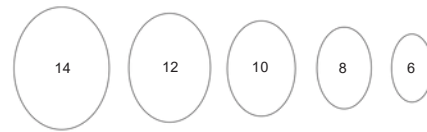

Code	DeTscription
TI-OR/151	Width 6mm
TI-OR/152	Width 8mm
TI-OR/153	Width 10mm
TI-OR/154	Width 12mm
TI-OR/155	Width 14mm

Simon Bone Curette

Straight, 240mm long

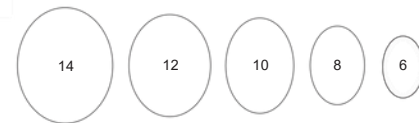

Code	DeTscription
TI-OR/145	Width 6mm
TI-OR/146	Width 8mm
TI-OR/147	Width 10mm
TI-OR/148	Width 12mm
TI-OR/149	Width 14mm

Spinal Curette

Oval, 205mm long

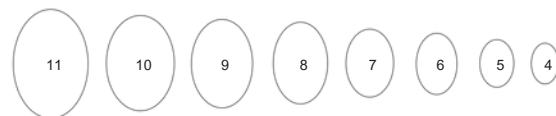

Code	DeTscription	Code	TI-	DeTscription
TI-OR/031a	Width 4mm	OR/031e		Width 8mm
TI-OR/031b	Width 5mm	TI-OR/031f		Width 9mm
TI-OR/031c	Width 6mm	TI-OR/031g		Width 10mm
TI-OR/031d	Width 7mm	TI-OR/031h		Width 11mm

Bone Curettes



Volkman Bone Curette

Straight, 170mm long

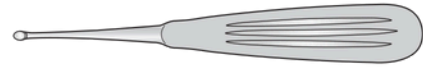

Code	TI-	DeTription	Code	TI-	DeTription
OR/112		Width 2mm	OR/117		Width 8mm
TI-OR/113		Width 3mm	TI-OR/118		Width 10mm
TI-OR/114		Width 4mm	TI-OR/119		Width 12mm
TI-OR/115		Width 5mm	TI-OR/120		Width 14mm
TI-OR/116		Width 6mm			

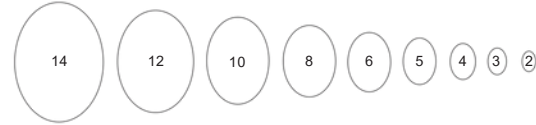

Volkman Bone Curette

Straight, 230mm long



Code	DeTription
TI-OR/SH.5687	Bowl width 10mm, bowl length 14.5mm

Wallich Bone Curette

Blunt

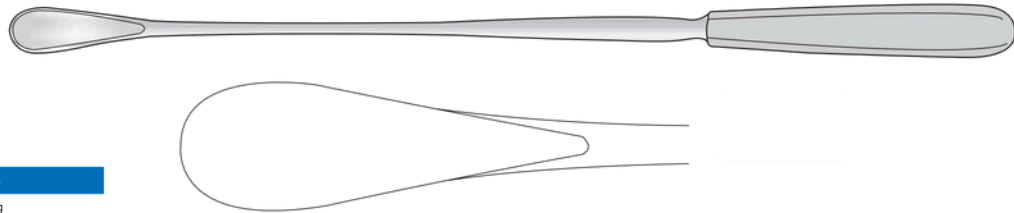

Code	DeTription
TI-OR/162	420mm long

Williger Bone Curette

Straight, 170mm long



Code	TI-	DeTription
OR/122		Width 3.5mm
TI-OR/123		Width 5.5mm



Charnley Bone Curette

With T handle,
380mm long

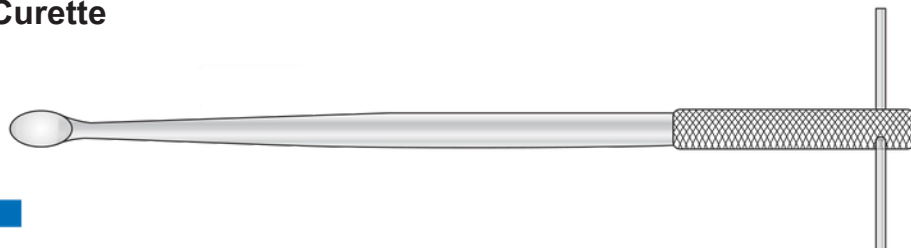

Code	TI-	DeTription
OR/N040		Large, 20 x 14mm
TI-OR/N041		Medium, 17 x 12mm
TI-OR/N042		Small, 11 x 8mm

Sypert Bone Curette

Blue acetal "Suregrip" handle, 380mm long



Straight

Code	DeTription
TI-OR/236	Width 3mm
TI-OR/237	Width 4mm
TI-OR/238	Width 5mm

Angled

Code	Ti-	DeTription
OR/240		Width 3mm
TI-OR/241		Width 4mm
TI-OR/245		Width 5mm



Bone Curette

Blue acetal "Suregrip" handle, 410mm long



Straight

Code	DeTription
TI-OR/249	Width 3mm
TI-OR/250	Width 4mm
TI-OR/251	Width 5mm

Angled

Code	Ti-	DeTription
OR/252		Width 3mm
TI-OR/253		Width 4mm
TI-OR/254		Width 5mm



Caspar Bone Curette

Blue acetal "Suregrip" handle, 220mm long



Straight

Code	DeTription
TI-OR/230	Width 3.5mm
TI-OR/231	Width 4.5mm
TI-OR/232	width 5.5mm

Angled

Code	Ti-	DeTription
OR/233		Width 3.5mm
TI-OR/234		Width 4.5mm
TI-OR/235		Width 5.5mm



Bone Curette

Blue acetal "Suregrip" handle, 270mm long, straight



Code	DeTription
TI-OR/226	Width 4mm
TI-OR/227	Width 6mm
TI-OR/228	Width 8mm
TI-OR/229	Width 10mm

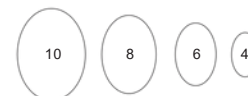

Bone Currettes

Capener Spoon

Blue acetal "Suregrip" handle 285mm long



Code	TI-	DeTription
OR/389a		Width 16mm
TI-OR/389b		Width 20mm

Capener Lamina Curette

Blue acetal "Suregrip" handle 300mm long



Code	TI-	DeTription
OR/389c		12 x 32mm
TI-OR/389d		6 x 18mm

Stanley Boyd Curette

Double ended



Code	TI-	DeTription
OR/162a		Small - 50mm long
TI-OR/162b		Medium - 200mm long
TI-OR/162c		Large - 250mm long

Volkman Bone Tloop

Double-ended, straight



Code	TI-	DeTription
OR/31	TI-	175mm long
OR/213		220mm long
TI-OR/175		220mm long

Martini Bone Curette

Shown at half size
double-ended, straight 140mm long



Code	TI-	DeTription
OR/170		Small and medium
TI-OR/171		Medium and large

Lane Bone Lever

240mm long

6mm

Code	TI-	DeTription
OR/N011		Slight curve
TI-OR/N012		Full curve

8mm

Code	TI-	DeTription
OR/N013		Slight curve
TI-OR/N014		Full curve



Lane Bone Lever

For small bones

Code	DeTription
TI-OR/N015	10mm wide, 265mm long



Lane Bone Lever

For small bones, serrated end

Code	DeTription
TI-OR/N016	10mm wide, 260mm long



Trethowan Bone Lever

Ring handle

Code	DeTription
TI-OR/N017	220mm long



Watson-Jones Bone Lever

Code	DeTription
TI-OR/N054	275mm long



Bankhart Bone Lever

Code	DeTription
TI-OR/SH.5315	300mm long



Retractors

Hip Set



Femoral Dislocation Lever 285mm

Code	DeTription
TI-OR/N059A	Spoon elevator 25mm with blue acetal suregrip handle – large



Curved Osteotome 260mm

Code	DeTription
TI-OR/N059D	With blue acetal suregrip handle - 2



Muller Curette 240mm

Code	DeTription
TI-OR/N059B	Curette 27mm with blue acetal suregrip handle – large



Small Gouge 240mm

Code	DeTription
TI-OR/N059E	8mm cranked blue acetal suregrip handle



Muller Curette 270mm

Code	DeTription
TI-OR/N059C	Curette 9mm with blue acetal suregrip handle – small

Charnley Initial Incision Retractor

Code	TI-	DeTription
OR/N038a		Frame only
TI-OR/N038b		Weight only, 75mm x 50mm ø
TI-OR/N038s		Goal post pins and chain

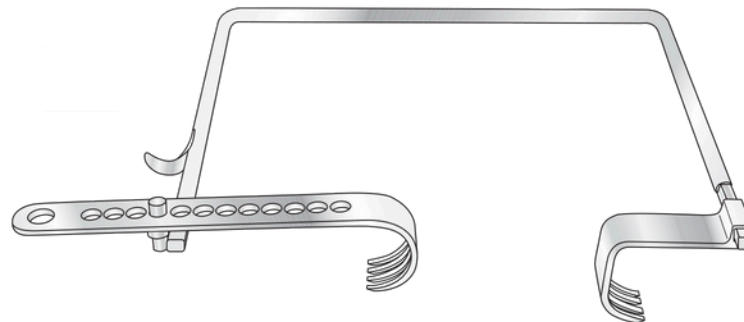

Short blades

Code	DeTription	Short blade,
TI-OR/N038r		25mm deep Short blade,
TI-006084		35mm deep Short blade,
TI-OR/N038c		50mm deep Short blade,
TI-OR/N038l		65mm Short blade, 75mm
TI-OR/N038e		deep Short blade, 80mm
TI-OR/N038q		deep Short blade, 100mm
TI-OR/N038g		deep Short blade, 125mm
TI-003879		Short blade, 150mm
TI-003880		

Long blades

Code	TI-	DeTription	Long blade,
006085	TI-		35mm deep Long blade,
OR/N038d	TI-		50mm deep Long blade,
OR/N038k	TI-		65mm Long blade, 70mm
OR/N038p	TI-		deep Long blade, 75mm deep
OR/N038f	TI-		Long blade, 100mm deep
OR/N038h	TI-		Long blade, 125mm Long
003877	TI-		blade, 150mm Long round
003878	TI-		blade, 50mm deep
OR/N038m			

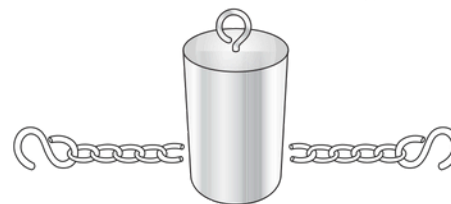

Travers Retractor

Self retaining, internal rack, 210mm long

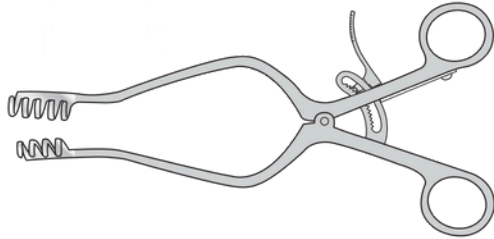

Code	DeTription
TI-GI/323	4 x 5 teeth, 95mm fully open

Jackson Burrows Retractor

Self retaining

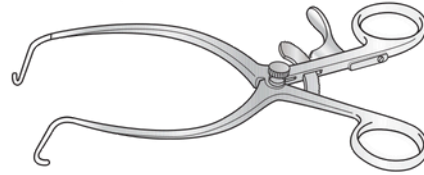

Code	DeTription
TI-GI/377	175mm

West Retractor

Self retaining, 140mm long

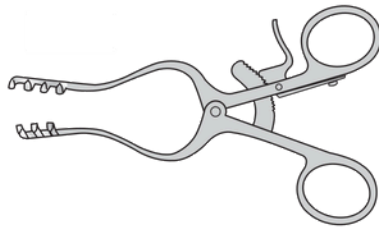

Code	DeTription
TI-GI/326	3 x 4 teeth, 60mm fully open
TI-GI/326cr	3 x 4 teeth, 60mm fully open, with cam rack

Norfolk and Norwich Retractor

4 x 5 teeth 50mm blades x 223mm long

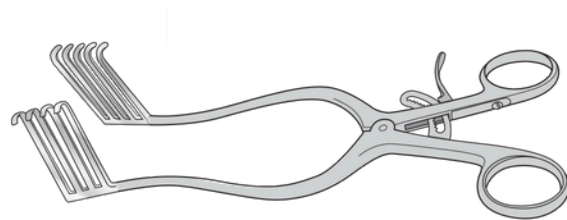

Code	DeTription
TI-GI/325	Standard rack

Retractors, Dissecting Forceps and Hooks

Jackson Burrows Hand Retractor

225mm long

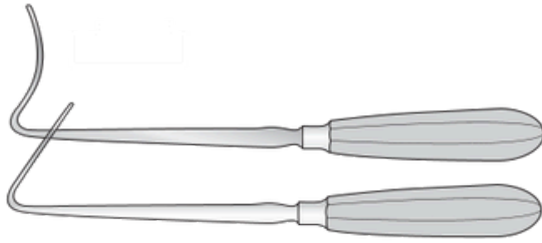

Code	DeTription
TI-OR/N050	Narrow curve, 13mm blade
TI-OR/N050a	Broad, angular, 20mm blade

Kocher Bone Hook

220mm long



Code	DeTription
TI-OR/N036	Sharp
TI-OR/N036a	Blunt

Ballance (Volkmann) Retractor

203mm long



Sharp

Code	TI-	DeTription
GI/463	TI-	1 prong 2
GI/463a		prong 3
TI-GI/463b		prong 4
TI-GI/463c		prong 6
TI-GI/463d		prong

Blunt

Code	TI-	DeTription
GI/463e		1 prong 2
TI-GI/463f		prong 3
TI-GI/463g		prong 4
TI-GI/463h		prong 6
TI-GI/463i		prong

Langenbeck Bone Hook



Code	DeTription
TI-OR/391	200mm long

Dislocation Hook



Code	DeTription
TI-OR/SH-5703	253mm long

Jackson Burrows Dissecting Forcep

140mm long



Code	DeTription
TI-OR/N037	Tongue and groove only
TI-OR/N037a	Tongue and groove, 1-2 teeth

Dislocation Hip Hook

Blue acetal "Suregrip" handle



Code	DeTription
TI-OR/420	185mm long

Charnley-McIndoe Dissecting Forceps

150mm long



Code	DeTription
TI-OR/N045a	2-3 teeth

Key Raspatories



Code	DeTRIPTION
TI-OR/310	Width 6.4mm 180mm long
TI-OR/313	Width 9.5mm 190mm long
TI-OR/311	Width 12.7mm 190mm long
TI-OR/312	Width 19mm 200mm long
TI-OR/314	Width 25.4mm 210mm long

Lambotte Raspatory

205mm Long



Code	DeTRIPTION
TI-OR/242	Width 10mm
TI-OR/243	Width 15mm
TI-OR/244	Width 20mm

Paton Bone Burr

Satin handle, 155mm long

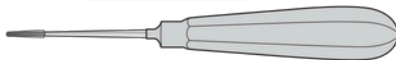

Code	DeTRIPTION
TI-OR/403	3.5mm ø x 17mm
TI-OR/403a	4.5mm ø x 17mm
TI-OR/403b	5.0mm ø x 17mm

Robert Jones Rugine

Convex sharp edge, fan shaped end, with solid pistol handle

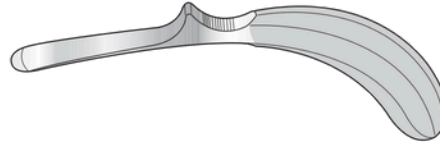

Code	DeTRIPTION
TI-OR/N035	185mm long

Mitchell Rugine

Straight, sharp edge, fan shaped, hollow handle

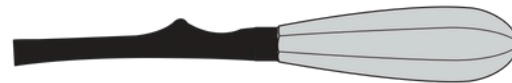

Code	DeTRIPTION
TI-OR/N034	210mm long

Farabeuf Rugine

Curved end, chisel edge, hollow handle

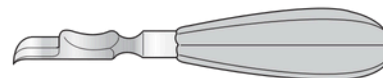

Code	DeTRIPTION
TI-OR/N033	160mm long

Osteotomes, Chisels and Gouges

Lexer Osteotome

Blue acetal "Suregrip" handle, 180mm long



Code	DeTription
TI-OR/SH5347a	4mm

Capener Lamina Gouge

Blue acetal "Suregrip" handle, straight, 265mm long



Code	TI-	DeTription	Code	TI-	DeTription
OR/362		Width 6mm	OR/365		Width 15mm
TI-OR/363		Width 10mm	TI-OR/366		Width 20mm
TI-OR/364		Width 12mm	TI-OR/367		Width 25mm

Capener Osteotome

Blue acetal "Suregrip" handle, 250mm long



Shallow curved

Code	TI-	DeTription
OR/384		Width 6mm
TI-OR/385		Width 10mm
TI-OR/386		Width 12mm
TI-OR/387		Width 15mm
TI-OR/388		Width 20mm
TI-OR/389		Width 25mm
TI-OR/390		Width 30mm

Acute curved

Code	TI-	DeTription
OR/390a		Width 6mm
TI-OR/390b		Width 10mm
TI-OR/390c		Width 15mm
TI-OR/390d		Width 20mm
TI-OR/390e		Width 25mm

Capener Lamina Gouge

Cranked, blue acetal "Suregrip" handle, 250mm long



With reversed edge

Code	DeTription	Code	DeTription
TI-OR/373c	Width 6mm	TI-OR/373cre	Width 6mm
TI-OR/373d	Width 8mm	TI-OR/373dre	Width 8mm
TI-OR/373j	Width 10mm	TI-OR/373jre	Width 10mm
TI-OR/373e	Width 11mm	TI-OR/373er	Width 11mm
TI-OR/373f	Width 16mm	TI-OR/373fre	Width 16mm
TI-OR/373k	Width 17mm	TI-OR/373kre	Width 17mm

OTHER LENGTHS AND SIZES AVAILABLE

Capener Osteotome

Blue acetal "Suregrip" handle, straight, 255mm long



Code	TI-	DeTription	Code	TI-	DeTription
OR/374		Width 6mm	OR/379		Width 15mm
TI-OR/375		Width 8mm	TI-OR/380		Width 18mm
TI-OR/376		Width 10mm	TI-OR/381		Width 20mm
TI-OR/377		Width 12mm	TI-OR/382		Width 25mm
TI-OR/378		Width 13mm	TI-OR/383		Width 30mm

Capener Lamina Gouge

Swan neck, blue acetal "Suregrip" handle, 250mm long



Code	DeTription
TI-OR/373g	Width 8mm

Capener Chisel

Blue acetal "Suregrip" handle straight, 250mm long



Code	TI-	DeTription	Code	TI-	DeTription
OR/368		Width 6mm	OR/371		Width 15mm
TI-OR/369		Width 10mm	TI-OR/372		Width 20mm
TI-OR/370		Width 12mm	TI-OR/373		Width 25mm

Capener Lamina Gouge

Reverse cranked, blue acetal "Suregrip" handle, 245mm long



Code	TI-	DeTription	Code	TI-	DeTription
OR/373ar	TI-	Width 11mm	OR/3730r	TI-	Width 6mm
OR/373nr	TI-	Width 16mm	OR/3731r	TI-	Width 8mm
OR/373jr		Width 17mm	OR/373mr		Width 10mm

Read Osteotome

Serrated head
180mm long



Code	DeTription
TI-OR/335	Width 4mm
TI-OR/336	Width 5mm

Swedish Pattern Chisel

200mm long



With tungsten carbide edge

Code	TI-	DeTription	Code	TI-	DeTription
OR/353		Width 10mm	OR/355tc		Width 20mm
TI-OR/354		Width 15mm	TI-OR/356tc		Width 25mm
TI-OR/355		Width 20mm	TI-OR/357tc		Width 30mm
TI-OR/356		Width 25mm	TI-OR/356tc		Width 25mm
TI-OR/357		Width 30mm	TI-OR/357tc		Width 30mm

Read Gouge

Serrated head, 180mm long



Code	DeTription	Code	TI-	DeTription
TI-OR/344	Width 2mm	OR/341		Width 6mm
TI-OR/345	Width 3mm	TI-OR/342		Width 7mm
TI-OR/346	Width 4mm	TI-OR/343		Width 8mm
TI-OR/347	Width 5mm			

Swedish Pattern Gouge

200mm long



With tungsten carbide edge

Code	TI-	DeTription	Code	TI-	DeTription
OR/358		Width 10mm	OR/358tc		Width 10mm
TI-OR/359		Width 15mm	TI-OR/359tc		Width 15mm
TI-OR/360		Width 20mm	TI-OR/360tc		Width 20mm
TI-OR/361		Width 25mm	TI-OR/361tc		Width 25mm

Read Chisel

Serrated head, 180mm long



Code	DeTription	Code	TI-	DeTription
TI-OR/337	Width 2mm	OR/341		Width 6mm
TI-OR/338	Width 3mm	TI-OR/342		Width 7mm
TI-OR/339	Width 4mm	TI-OR/343		Width 8mm
TI-OR/340	Width 5mm			

Lambotte Osteotome

230mm long



Swedish Pattern Osteotome

200mm long



Code	DeTription	With tungsten carbide edge		
Code	TI-	DeTription		
TI-OR/348		Width 10mm	OR/348tc	Width 10mm
TI-OR/349		Width 15mm	TI-OR/349tc	Width 15mm
TI-OR/350		Width 20mm	TI-OR/350tc	Width 20mm
TI-OR/351		Width 25mm	TI-OR/351tc	Width 25mm
TI-OR/352		Width 30mm	TI-OR/352tc	Width 30mm

Straight

Code	TI-	DeTription
OR/392	TI-	2mm wide
OR/392a		4mm wide
TI-OR/392b		7mm wide
TI-OR/392c		15mm wide
TI-OR/392d		20mm wide
TI-OR/392e		25mm wide
TI-OR/392f		30mm wide
TI-OR/392g		38mm wide
TI-OR/392h		44mm wide
TI-OR/392i		50mm wide

Curved

Code	DeTription
TI-OR/392j	15mm wide
TI-OR/392k	20mm wide
TI-OR/392m	25mm wide
TI-OR/392n	30mm wide
TI-OR/392o	38mm wide
TI-OR/392p	40mm wide
TI-OR/392q	44mm wide
TI-OR/392r	50mm wide

Osteotomes, Chisels and Gouges



Albee Osteotome

190mm long

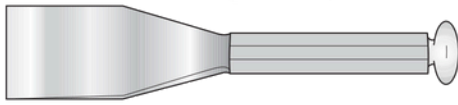

Code	TI-	DeTription
OR/NO62a		Width 38mm
TI-OR/NO62b		Width 50mm

Small Gouges

150mm long



Code	TI-	DeTription
OR/16-4		4mm wide
TI-OR/16-6		6mm wide
TI-OR/16-8		8mm wide

Moore Hollow Osteotome

Rectangular, for curved standard stems



Code	DeTription
TI-OR/N008	135mm long
TI-OR/N008a	255mm long

Box Chisel

Blue acetal "Suregrip" handle, 285mm long



Code
TI-OR/N008b

Small Osteotomes

150mm long



Code	TI-	DeTription
OR/14-4		4mm wide
TI-OR/14-6		6mm wide
TI-OR/14-8		8mm wide

Alexander Gouge

Straight, 170mm long



Code	TI-	DeTription
OR/290		Width 5mm
TI-OR/291		Width 7mm

Code	TI-	DeTription
OR/292		Width 9mm
TI-OR/293		Width 11mm

Small Chisels

150mm long



Code	TI-	DeTription
OR/18-4		4mm wide
TI-OR/18-4		6mm wide
TI-OR/18-4		8mm wide

PartTh Gouge

Straight



140mm long

Code	TI-	DeTription
OR/283		Width 3mm
TI-OR/284		Width 4mm
TI-OR/285		Width 5mm
TI-OR/286		Width 6mm

170mm long

Code	TI-	DeTription
OR/294		Width 3mm
TI-OR/287		Width 4mm
TI-OR/295		Width 5mm
TI-OR/288		Width 6mm
TI-OR/289		Width 7mm

Wire Cutting Pliers

Tungsten carbide edge, for cutting up to and including 6mm \varnothing

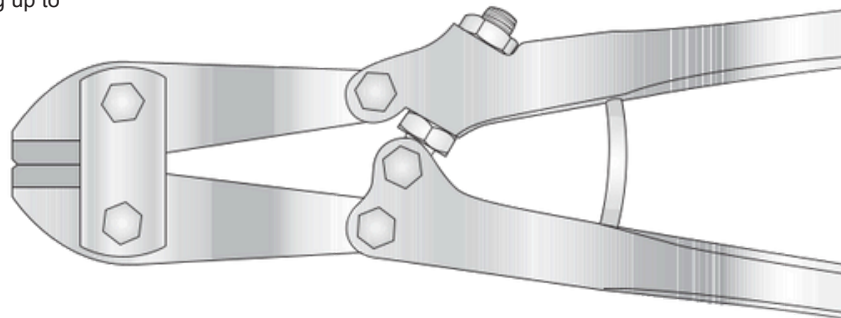

Code	Description
TI-OR/258	450mm long
TI-OR/259	560mm long

Wire Cutting Pliers

Tungsten carbide edge, for cutting KirTIhner wires up to and including 5.5mm \varnothing

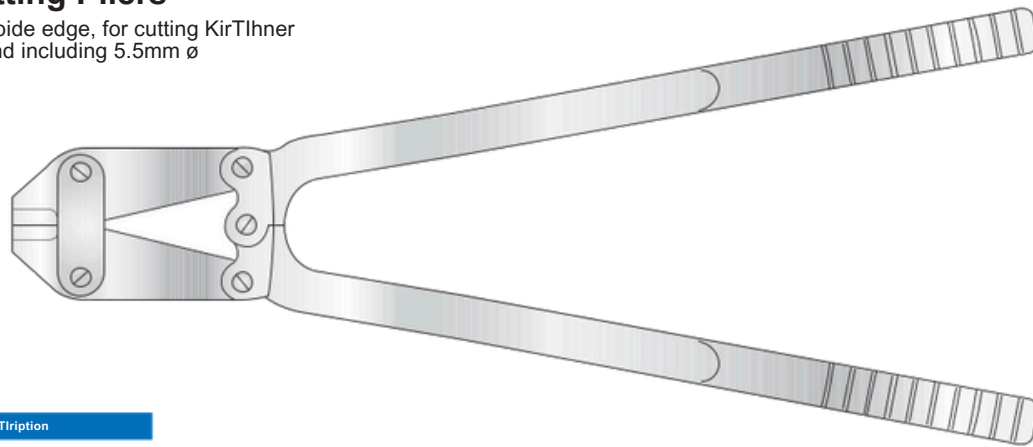

Code	Description
TI-OR/07a	480mm long

Wire Cutting Pliers

Tungsten carbide edge, for cutting KirTIhner wires up to 4mm \varnothing

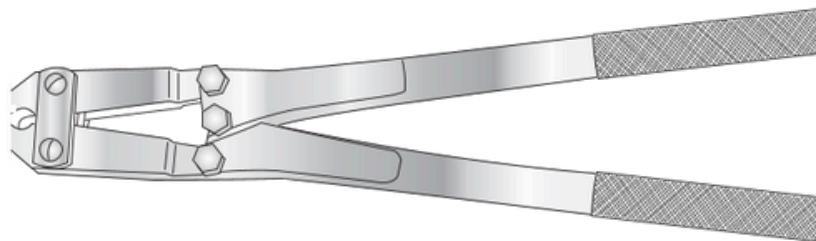

Code	Description
TI-OR/261	380mm long

Top Cutter

Gold handles, tungsten carbide edge, for cutting KirTIhner wire

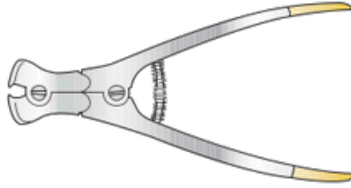

Code	DeTription
TI-OR/06	Up to 2.5mm, 215mm long Up to 1.5mm,
TI-OR/06a	145mm long

Side Cutter

Gold handles, tungsten carbide edge, jaws have rounded edges, for cutting KirTIhner wires

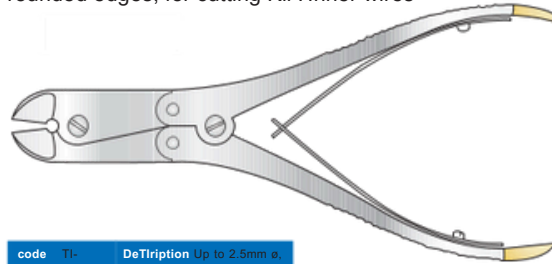

code	TI-	DeTription
OR/331		Up to 2.5mm ø, 230mm long Up to 2.2mm ø,
TI-OR/332		215mm long Up to 1.5mm ø,
TI-OR/333		145mm long

Top and Side Cutter

Small, gold handles, tungsten carbide edge, for cutting KirTIhner wires up to 1.5mm ø

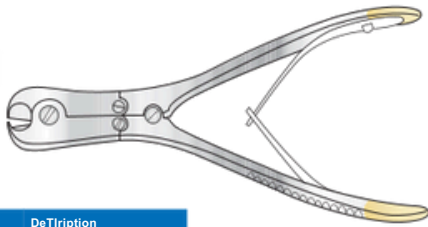

Code	DeTription
TI-OR/06b	175mm long

Wire Cutting Pliers

Gold handles, tungsten carbide edge, 120mm long

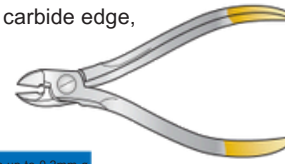

Code	TI-	DeTription
OR/263		For wire up to 0.2mm ø
TI-OR/267		For wire up to 0.3mm ø For wire up to 0.5mm ø For wire up to 0.5mm ø
TI-OR/262		115mm long For wire up to 0.7mm ø
TI-OR/269		ø
TI-OR/268		

Side Cutter

Compound action, angled tungsten carbide jaw, gold handles, for KirTIhner wire up to 1.6mm ø

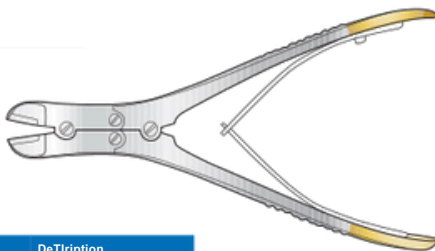

Code	DeTription
TI-OR/N060	180mm long

Orthopaedic Plier/Cutter

Stainless steel



Code	TI-	DeTription
OR/271b		180mm long
TI-OR/271c		220mm long

Side Cutter

Gold handles, tungsten carbide edge, for cutting KirTIhner wires up to 1.5mm ø

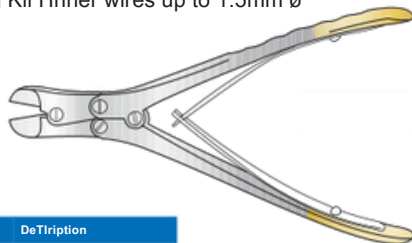

Code	DeTription
TI-OR/260	170mm long

Bone Plate Bender/Wire Cutter Pliers

For nipping and breaking of soft wire only
Not suitable for KirTIhner wires



Code	DeTription
TI-OR/32a	150mm long

Pliers for Wire

175mm long



Code
TI-OR/273



Code
TI-OR/275

Orthopaedic Plier/Cutter

Stainless steel, tungsten carbide edge, for cutting KirTIhner wire up to 1.6mm

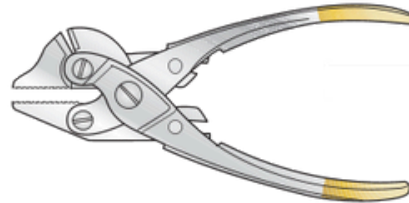

Code	TI-	DeTRIPTION
OR/271a		TC 180mm long
TI-OR/271b		Non TC for cutting soft wire only, max cut 1.6mm, 180mm long

Pliers for Bone Burrs

190mm long



Code
TI-OR/274

Mole Grip Type Wrench

Stainless steel

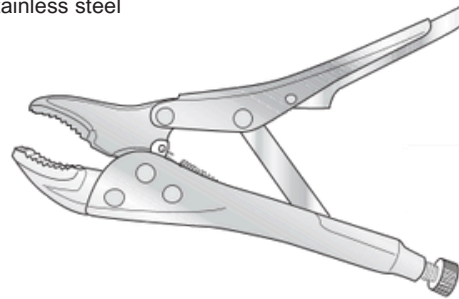

Orthopaedic Pliers

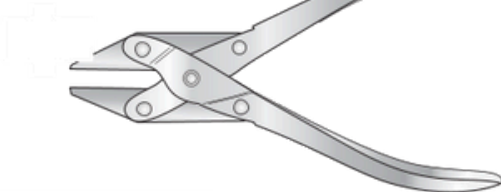

Code	DeTRIPTION
TI-OR/49b	185mm

Code	DeTRIPTION
TI-OR/N052	190mm long

Accessories

Wire Twister Biomet Type



Code	DeTRIPTION
TI-OR/49a	150mm long

Suture Wire Cutting Tlissors

Angled to cut soft wire only, max cut 1.2mm



Code	DeTRIPTION
TI-OR/07b	120mm long

Martin Cartilage Forceps



Code	DeTRIPTION
TI-OR/393	180mm long

Suture Wire Cutting Tlissors



Code	DeTRIPTION
T I - O R /07c	110mm long

Charnley Suture Forcep

Slotted, 1-2 teeth



Code	DeTRIPTION
TI-OR/N045	180mm long

Mallet

With serrated head, 170mm long



Code	DeTription
TI-OR/023	190 grams

Mallet

Blue acetal, 240mm long

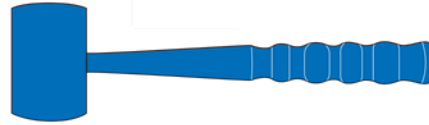

Code	DeTription
TI-OR/LE1001	340 grams, vertical end

Mallet

Blue acetal "Suregrip" handle, 275mm long

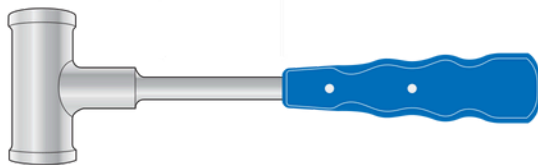

Code
TI-OR/270A-BH

Mallet

Blue acetal, 255mm long

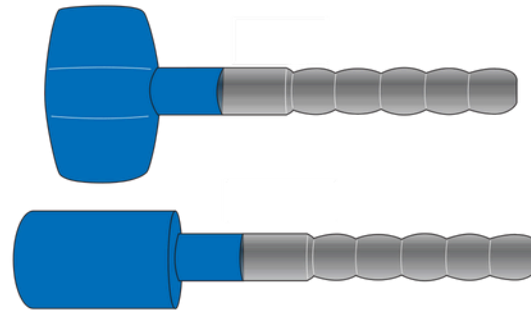

Code	DeTription
TI-OR/22a	520 grams, vertical end
TI-OR/22	650 grams, horizontal end

Mallet

Stainless steel, 270mm long

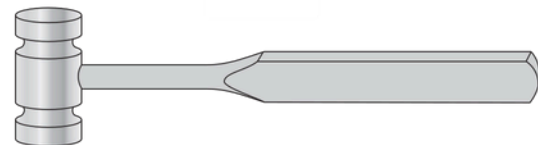

Code	TI-	DeTription
OR/270		640 grams
TI-OR/271		1020 grams

Heath Mallet

Stainless steel, 135mm long

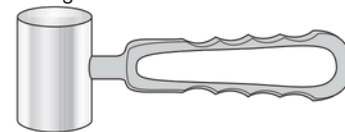

Code	TI-	DeTription	Code	DeTription
OR/N044c		650 grams	TI-OR/N044	1150 grams
TI-OR/N044b		920 grams	TI-OR/N044a	1340 grams

Mallet

Stainless steel, with pistol grip*
240mm long

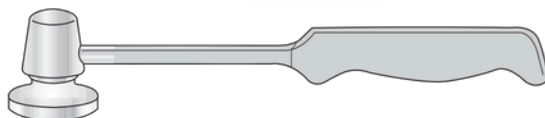

Code	DeTription
TI-OR/20	580 grams

*ALSO AVAILABLE WITH
BLUE ACETAL HANDLE

Royal Cornwall Mallet

Stainless steel, with extended handle and strong welded head, 190mm long

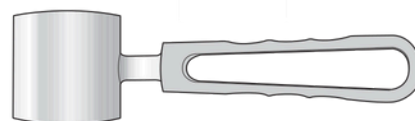

Code	DeTription
TI-OR/N044rc	1000 grams

Mallets

Orthopaedic Mallet

Surgical Holdings pattern, stainless steel, 170mm long

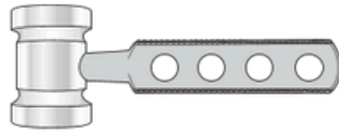

Code	DeTriage
TI-OR/N055b	800 grams
TI-OR/N055	880 grams
TI-OR/N055a	1020 grams

Kelsey Fry Mallet

With renewable acetal ends, 190mm long



Code	DeTriage
TI-OR/N047a	280 grams
TI-OR/N048	Replacement end - pair

Orthopaedic Mallet

Stainless steel, Surgical Holdings pattern, one flat and one domed end, 180mm long



Code	TI-	DeTriage
OR/272a		960 grams
TI-OR/272c		750 grams

Surgical Holdings Orthopaedic Mallet

Stainless steel with blue acetal "Suregrip" handle 270mm long

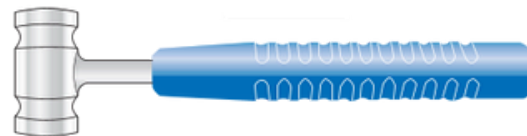

Code	TI-	DeTriage	Code	TI-	DeTriage
OR/410		720 grams	OR/412		900 grams
TI-OR/411		800 grams	TI-OR/413		970 grams

Toëe Hammer

Stainless steel, one plain and one serrated side, 190mm long



Code	DeTriage
TI-OR/N047	280 grams

Surgical Holdings Orthopaedic Mallet

Stainless steel with blue acetal "Suregrip" handle 200mm long



Code	TI-	DeTriage	Code	TI-	DeTriage
OR/414BH		660 grams	OR/416BH		1020 grams
TI-OR/415BH		790 grams	TI-OR/417BH		1400 grams

Ombredanne Mallet

Stainless steel, one flat and one domed end

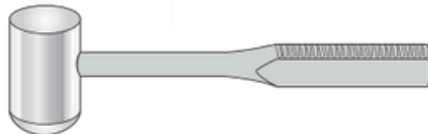

Code	DeTriage
TI-OR/272	950 grams, 240mm long
TI-OR/272b	1110 grams, 270mm long

Surgical Holdings Mallet

Stainless steel with blue acetal "Suregrip" handle domed faced head, 200mm long



Code	DeTriage
TI-OR/418BH	650 grams

Collin Mallet

Stainless steel, 205mm long



Code	DeTriage
TI-OR/23	270 grams

Putti Raspatory



Code	DeTription
TI-OR/12	300mm long

OTHER SHAPES AND CONFIGURATIONS ON REQUEST

Bone File and Raspatory

Stainless steel



Code	DeTription
TI-OR/12a	215mm long

Austin Moore Type Raspatory

Including tommy bar,
295mm long

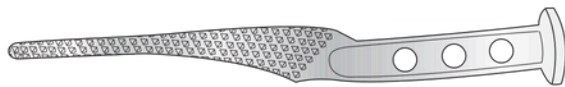

Code	TI-	DeTription
OR/HP001		Standard
TI-OR/HP002		Narrow (not illustrated)

Thompson Type Raspatory

Including tommy bar

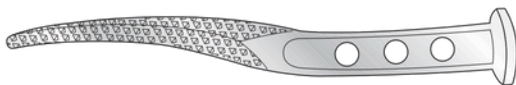

Many other types available
Supply a drawing of the prosthesis - we will make the rasp in any batch size you require. The teeth will be chipped up at 0.75mm per face over and above the size of the prosthesis stem, to allow for cementing.

Code	DeTription
TI-OR/HP003	270mm long

Miller Bone File

180mm long

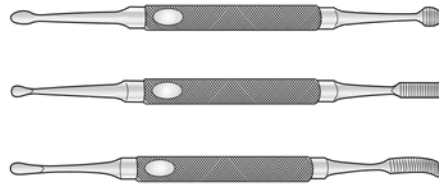

Code	TI-	DeTription
OR/318		Short end
TI-OR/319		Slight curve
TI-OR/322		Full curve

McGoey Punch

Double ended, 220mm long



4



4a



4b

Code	TI-	DeTription
OR/N04	TI-	13 x 19mm
OR/N04a		6 x 10mm
TI-OR/N04b		13 x 6mm half round

Smillie Bone Punch



Head size 15 x 19.5mm



Head size 9.5 x 15.5mm

Code	TI-	DeTription	Straight
OR/N018		140mm long Cranked	
TI-OR/N019		175mm long	

Pushers, Impactors and SkidT

Iharnley Cup Pusher

With nylon head



Code	DeTriage
TI-OR/N020	295mm long

Hardinge Cement Restrictor

With T handle



Code	DeTriage
TI-OR/HR001	335mm long

Charnley Prosthesis Pusher

Stainless steel handle
with nylon insert



Code	DeTriage
TI-OR/N021	180mm long

Moore Femoral Head Extractor

With T handle



Code	TI-	DeTriage
OR/N005		150mm long
TI-OR/N006		205mm long

Judet Impactor

Stainless steel handle
with nylon head



Code	DeTriage
TI-OR/N009	140mm long

Murphy Skids

Double ended, 355mm long



Code	DeTriage
TI-OR/N007	Uncoated
TI-DIA/111	Coated

Femoral Pusher

Head impactor, white Pomalux



Code	DeTriage
TI-OR/N053	31mm ø x 180mm long

Murphy Skids

Single ended, 330mm long



Code	DeTriage
TI-OR/N007a	Coated

Adson Periosteal Elevator

Serrated grip, 165mm long

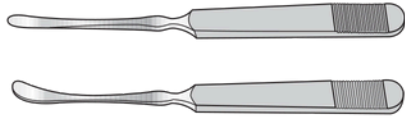

straight

Code	DeTription
TI-OR/N028	7mm wide

curved

Code	TI-	DeTription
OR/N029	5mm	wide
TI-OR/N030		7mm wide

Langenbeck Elevator

Straight



Code	DeTription
TI-OR/302	200mm long

Bristow Periosteal Elevator

Sharp edge



Code	DeTription
TI-OR/N010	240mm long

MacDonald Dissector Double Ended



Code	DeTription
TI-GI/285	191mm long

Doyen Periosteal Elevator

Satin finish handle

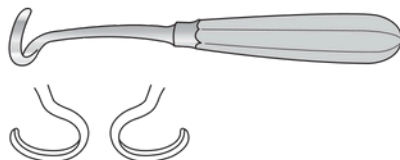

165mm long

Code	DeTription
TI-OR/N031	Right
TI-OR/N032	Left

180mm long

Code	TI-	DeTription
OR/256	Right	
TI-OR/255	Left	

Pennybacker Elevator

Curved, sharp, 6mm wide

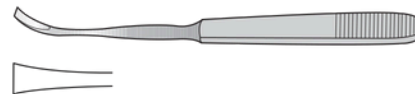

Code	DeTription
TI-OR/N025	170mm long

Key Periosteal Elevator

190mm long



Code	DeTription
TI-OR/N023	10mm wide
TI-OR/N024	13mm wide

Periosteal Elevator

Straight



Code	DeTription
TI-OR/19a	175mm long

Elevators

Periosteal Elevator

Straight, 12 x 20mm, with blue acetal "Suregrip" handle



Code	DeTription
TI-OR/SH-5695	195mm long

Periosteal Elevator

Curved, 5 x 25mm, with blue acetal "Suregrip" handle



Code	DeTription
TI-OR/SH-5696	185mm long

Tudor Edwards Periosteal Elevator

For first rib, satin finish handle, 175mm long

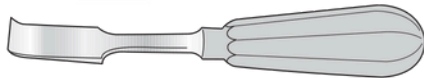

Code	TI-	DeTription
OR/N026		12mm wide
TI-OR/N027		18mm wide

Hohmann Bone Elevator

Matt finish, 160mm long



Code	TI-	DeTription
OR/307a		6mm wide
TI-OR/307b		8mm wide
TI-OR/307d		10mm wide
TI-OR/307e		15mm wide

Hohmann-Muller Spike Elevator

With narrow spade



Code	TI-	DeTription	220mm
OR/307f		long, 10mm wide	230mm
TI-OR/307		long, 12mm wide	240mm
TI-OR/308		long, 18mm wide	

Hohmann-Aldinger Bone Elevator

Curved

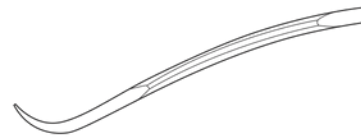

Code	DeTription
TI-OR/304	270mm long x 24mm wide

Hohmann Bone Elevator

Curved

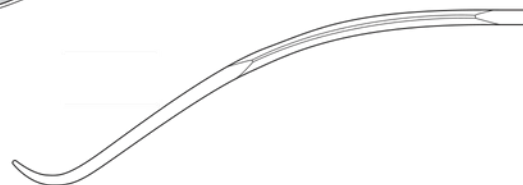

Code	DeTription
TI-OR/305	285mm long x 34mm wide

Hohmann Bone Lever

Curved, Leicester Royal Infirmary pattern



Code	DeTription
TI-OR/LGH-HOH	340mm long x 23mm wide

Wagner Bone Elevator

220mm long

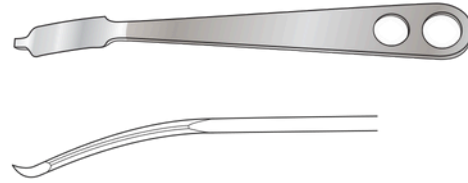

Code	DeTription
TI-OR/307h	17mm wide

Tlumacher Bone Elevator

290mm long

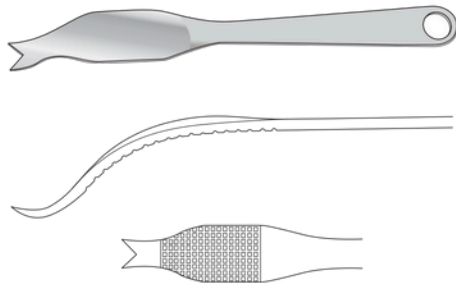

Code	DeTription
TI-OR/307k	35mm wide, 18mm at edge

Lange-Hohmann Bone Elevator

250mm long

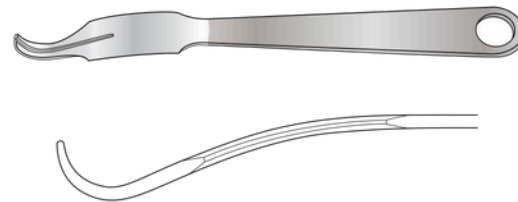

Code	DeTription
TI-OR/307i	24mm wide

Muller Soft Tissue Retractor

40mm wide

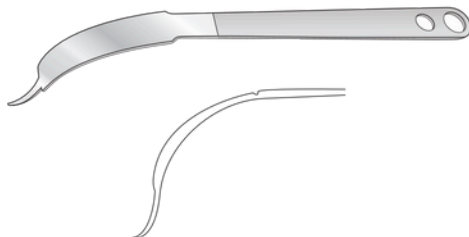

Code	TI-	DeTription
OR/307aNOR		410mm long
TI-OR/307bNOR		300mm long

Tlumacher Bone Elevator

345mm long

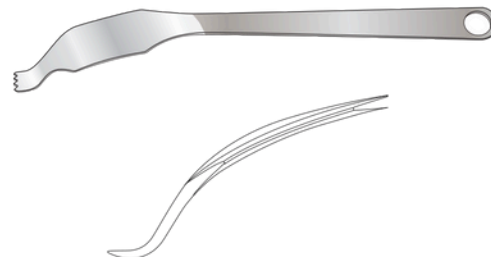

Code	DeTription
TI-OR/307j	37mm wide, 18mm at edge

Retractors and Bone Levers

Fakuda Type Retractor

230mm long

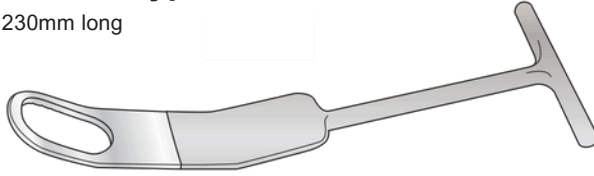

Code

TI-OR/SH5507

Trethowan Bone Lever

Bent, ring handle 222mm long, 280mm long

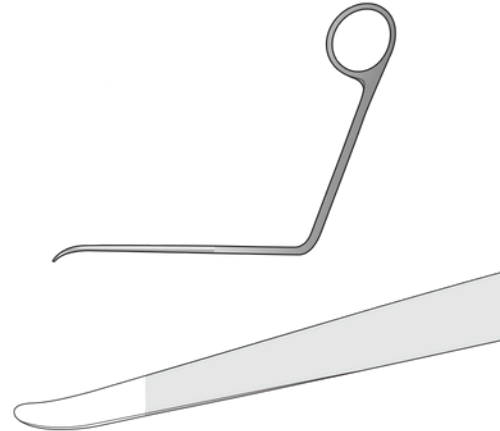

Hohmann Retractor

45° angle, 200mm long



Code

TI-OR/SH5394

Code	TI-	DeTription
OR/no17b		90° angle
TI-OR/no17c		70° angle (illustrated)
TI-OR/no17d		45° angle

Hohmann Tapered Spike Retractor

225mm overall length

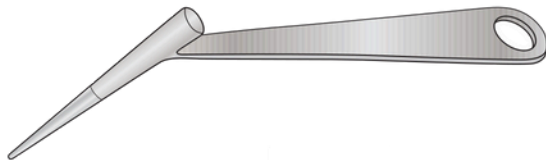

Code

TI-OR/308a

Posterior Bone Lever

230mm long



Code

TI-OR/308r

Gigli Saw Handles

Per pair

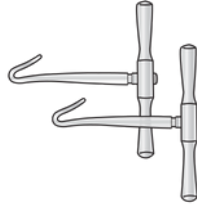

Code	DeTription
TI-OR/08	65mm long

Guys Tenotomy Knife



Code	DeTription
TI-OR/N046	140mm long

Charnley Saws

Code	TI-	DeTription
OR/10c		500mm long
TI-OR/11c		700mm long

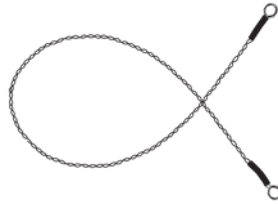

Smillie Menisectomy Knife

175mm long



Code	DeTription
TI-OR/048	Straight

Gigli Saws

Code	TI-	DeTription
OR/09		300mm long
TI-OR/10		500mm long
TI-OR/11		700mm long

Smillie Menisectomy Knife

Protruding beak at base, 175mm long

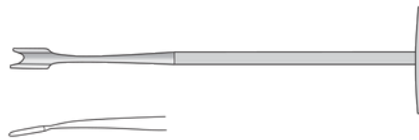

Collin Rib Shears

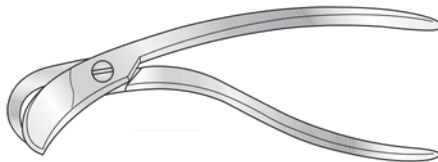

Code	DeTription
TI-OR/001	195mm long

Code	TI-	DeTription
OR/NO048a		Curved to right
TI-OR/NO048b		Curved to left

Tirew and Plate Instruments

Allen Key Sets

Bright guard



Code	DeTription
TI-OR/N051	1.5mm - 10mm

Size mm	Overall Length
1.5	63mm
2.0	77mm
2.5	87mm
3.0	93mm
4.0	104mm
5.0	120mm
6.0	141mm
7.0	147mm
8.0	158mm
10.0	180mm

To order quote TI-OR/N051 then add size required e.g. **TI-OR/N051-1.5**

Orthopaedic Ruler Stainless Steel



Code	DeTription
TI-OR/51a	Metric, 300mm

Pins

Denham Pin

Temporary implants, material conforms to BS 7252: Part 1: 1997. ISO 5832-1: 1997. Comp.D. CE marking available on request.



Code	Size
TI-DP/1-3SE	3.96mm dia x 203mm long trocar/3 side end
TI-DP/1SQ	3.96mm dia x 203mm long trocar/square end
TI-DP/2-3SE	3.96mm dia x 229mm long trocar/3 side end
TI-DP/2SQ	3.96mm dia x 229mm long trocar/square end

Code	Size
TI-DP/3-3SE	4.76mm dia x 203mm long trocar/3 side end
TI-DP/3SQ	4.76mm dia x 203mm long trocar/square end
TI-DP/4-3SE	4.76mm dia x 229mm long trocar/3 side end
TI-DP/4SQ	4.76mm dia x 229mm long trocar/square end

THREE SIDED END OR SQUARE END IN STOCK
OTHER SIZES AVAILABLE

Steinmann Pins

Temporary implants, material conforms to BS 7252: Part 1: 1997. ISO 5832-1: 1997. Comp.D. CE marking available on request



IPTT = trocar/trocar ends

Various specs available – contact us for full information



IPTS = trocar/trocar with one Tlrew end

Ø mm*	Ø mm*
1.58	3.96
2.00	4.36
2.38	4.76
2.78	6.00
3.17	6.35
3.57	8.00

LENGTHS 150, 180, 200, 250mm
*Other lengths and diameters available



IPTSE = trocar/square end



IPTSE3 = trocar/with 3 sided end

When ordering, use prefix letters with size following
e.g. Trocar with one Tlrew end
Ø4.76mm = IPTS/476

Bohler Stirrup

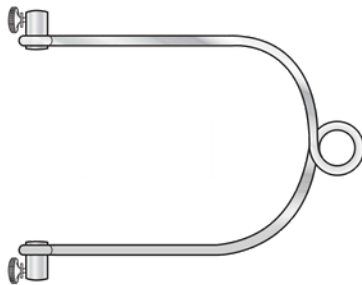

Code	TI-	DeTription
OR/N001		Small 89 x 102mm
TI-OR/N002		Medium 114 x 165mm
TI-OR/N003		Large 152 x 241mm

Steinmann Pin Cap with Tlrew

Code	DeTription
TI-OR/54b-4	4mm ø
TI-OR/54c	Replacement Tlrew



TI-OR 54b

Sterile KirTIhner and Arthrodesis Wires

Temporary implants, material conforms to BS 7252: Part 1: 1997. ISO 5832-1: 1997. Comp.D.

Sterile Trocar/ Sterile Trocar Arthrodesis Wires

Code	Size 0.8mm x	Code TI-	Size 1.1mm x	Code	Size 1.6mm x
TI-325A-S	70mm 0.9mm x	290-S TI-	200mm 1.25mm x	TI-005-S	50mm 1.6mm x
TI-037-S	70mm 0.9mm x	0019B-S	150mm 1.2mm x	TI-041-S	70mm 1.6mm x
TI-055-S	75mm 0.9mm x	TI-039-S	70mm 1.2mm x	TI-095-S	100mm 1.6mm x
TI-091-S	100mm 0.9mm x	TI-093-S	100mm 1.2mm x	TI-113-S	115mm 1.6mm x
TI-127-S	125mm 0.9mm x	TI-129-S	125mm 1.2mm x	TI-131-S	125mm 1.6mm x
TI-145-S	140mm 0.9mm x	TI-147-S	140mm 1.2mm x	TI-0012-S	150mm 1.6mm x
TI-0009-S	150mm 0.9mm x	TI-0010B-S	150mm 1.2mm x	TI-167-S	180mm 1.6mm x
TI-163-S	180mm 1.0mm x	TI-165-S	180mm 1.2mm x	TI-185-S	200mm 1.8mm x
TI-038-S	70mm 1.0mm x	TI-183-S	200mm 1.4mm x	TI-283-S	200mm 2.0mm x
TI-056-S	75mm 1.0mm x	TI-040-S	70mm 1.4mm x	TI-096-S	100mm 2.0mm x
TI-092-S	100mm 1.1mm x	TI-094-S	100mm 1.4mm x	TI-114-S	115mm 2.0mm x
TI-269-S	90mm 1.1mm x	TI-112-S	115mm 1.4mm x	TI-132-S	125mm 2.0mm x
TI-272-S	100mm 1.1mm x	TI-130-S	125mm 1.4mm x	TI-0013-S	150mm 2.0mm x
TI-275-S	115mm 1.1mm x	TI-148-S	140mm 1.4mm x	TI-168-S	180mm 2.0mm x
TI-278-S	125mm 1.1mm x	TI-0011-S	150mm 1.4mm x	TI-186-S	200mm
TI-281-S	140mm 1.1mm x	TI-166-S	180mm 1.4mm x		
TI-0010C-S	150mm	TI-184-S	200mm		

Sterile Trocar/Sterile KirTIhner Wires (Pack of 10 Sterile Singles)

Code	Size 0.8mm x	Code TI-	Size 1.1mm x	Code TI-	Size 1.6mm x
TI-325-S	70mm 0.9mm x	291-S TI-	200mm 1.25mm x	011-S T I-	50mm 1.6mm x
TI-043-S	70mm 0.9mm x	0015A-S	150mm 1.2mm x	0 47-S TI-	70mm 1.6mm x
TI-061-S	75mm 0.9mm x	TI-045-S	70mm 1.2mm x	101-S TI-	100mm 1.6mm x
TI-097-S	100mm 0.9mm x	TI-099-S	100mm 1.2mm x	119-S TI-	115mm 1.6mm x
TI-133-S	125mm 0.9mm x	TI-135-S	125mm 1.2mm x	137-S TI-	125mm 1.6mm x
TI-151-S	140mm 0.9mm x	TI-153-S	140mm 1.2mm x	0017-S	150mm 1.6mm x
TI-0014A-S	150mm 0.9mm x	TI-0019-S	150mm 1.2mm x	TI-173-S	180mm 1.6mm x
TI-169-S	180mm 1.0mm x	TI-171-S	180mm 1.2mm x	TI-191-S	200mm 1.8mm x
TI-044-S	70mm 1.0mm x	TI-189-S	200mm 1.4mm x	TI-475-S	200mm 2.0mm x
TI-062-S	75mm 1.0mm x	TI-046-S	70mm 1.4mm x	TI-102-S	100mm 2.0mm x
TI-098-S	100mm 1.1mm x	TI-100-S	100mm 1.4mm x	TI-120-S	115mm 2.0mm x
TI-270-S	90mm 1.1mm x	TI-118-S	115mm 1.4mm x	TI-138-S	125mm 2.0mm x
TI-273-S	100mm 1.1mm x	TI-136-S	125mm 1.4mm x	TI-0018-S	150mm 2.0mm x
TI-276B-S	115mm 1.1mm x	TI-154-S	140mm 1.4mm x	TI-174-S	180mm 2.0mm x
TI-279-S	125mm 1.1mm x	TI-0021-S	150mm 1.4mm x	TI-192-S	200mm
TI-282-S	140mm 1.1mm x	TI-172-S	180mm 1.4mm x		
TI-285-S	150mm	TI-190-S	200mm		

OTHER SIZES, FULL AND PARTIALLY THREADED STYLES ARE ALSO AVAILABLE PLEASE CONTACT US WITH YOUR REQUIREMENTS.

Extremities Instruments and Sets



Fine Hand Set

Includes: small stille type mallet 17cm long and 2mm, 4mm, 6mm, 8mm, 10mm and 12mm osteotomes

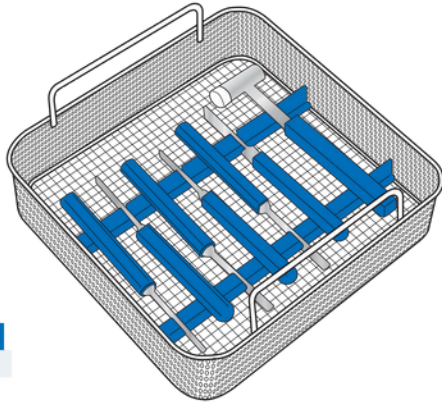

Code
SH-6969

Mini-Lexer Gouges

With blue acetal handle



Code	DeTription
TI-OR/587-04	4mm wide, 18cm long
TI-OR/587-06	6mm wide, 18cm long
TI-OR/587-08	8mm wide, 18cm long
TI-OR/587-10	10mm wide, 18cm long

Flexible Chisels and Blades



Code	TI-	DeTription
OR/593	TI-	Allen key for flat chisel blades introducer handle 185mm long
OR/594	TI-	Chisel blade 5mm for introducer handle
OR/594A		Chisel blade 5mm curved for introducer handle
TI-OR/595		Chisel blade 10mm for introducer handle
TI-OR/595A		Chisel blade 10mm curved for introducer handle
TI-OR/596		Chisel blade 15mm for introducer handle
TI-OR/596A		Chisel blade 15mm curved for introducer handle
TI-6954		Introducer handle for flat chisel blades 185mm long

Mini-Lexer Osteotome and Gouge Set

Includes 4mm, 6mm, 8mm, 10mm gouges 18cm long and 2mm, 4mm, 6mm, 8mm and 10mm osteotomes 18cm long

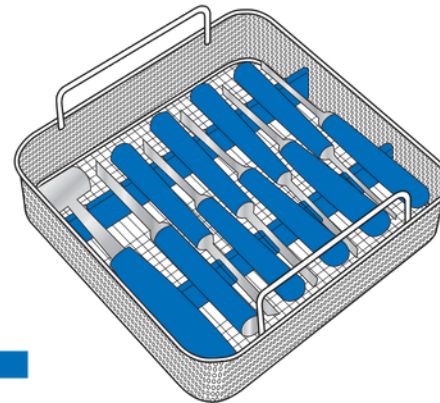

Code
TI-OR/587

Mini Fine Hand Osteotomes

With blue acetal handle



Code	DeTription	2mm. wide.
TI-6956	165mm long	4mm wide,
TI-6957	165mm long	6mm wide,
TI-6958	165mm long	8mm wide,
TI-6959	165mm long	10mm wide,
TI-6960	165mm long	12mm wide,
TI-6961	165mm long	

Mini-Lexer Osteotomes

With blue acetal handle



Code	TI-	DeTription
OR/588-02		2mm wide, 18cm long
TI-OR/588-04		4mm wide, 18cm long
TI-OR/588-06		6mm wide, 18cm long
TI-OR/588-08		8mm wide, 18cm long
TI-OR/588-10		10mm wide, 18cm long

Removable Flexible Chisel and Blade Set

With blue acetal handle

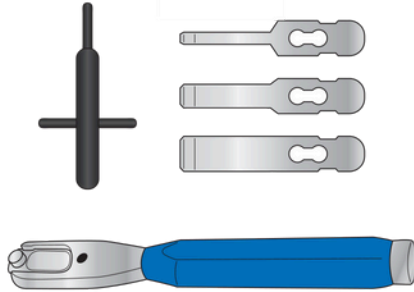

Code	DeTriage
SH-7002	5mm, 10mm and 16mm straight
SH-7002A	5mm, 10mm and 16mm curved

Chirobloc Hand Immobiliser



Code	DeTriage
CB3	ForgetMeNots Chirobloc Ballast Chirobloc
CBL	Large Chirobloc Small Chirobloc ForgetMeNot
CBM	Blue Chirobloc ForgetMeNot Yellow
CBP	
FMN2B.B	
FMN2B.Y	

Small Mallet

Small mallet 340 gram 210mm long with one flat and one round end fitted with blue acetal handle

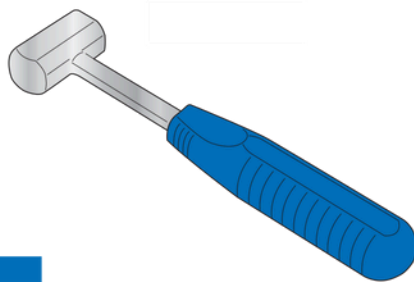

Code
SH-6955

Small Stille Type Mallet

Ultra fine mallet 180mm long with one nylon head fitted with a blue acetal handle 180 gram

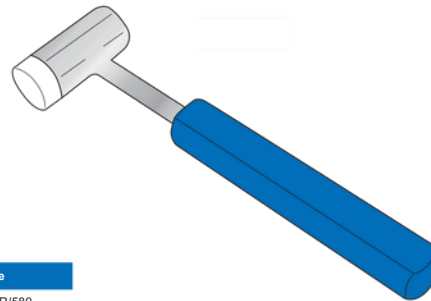

Code
TI-OR/580

Shoulder Instruments



Kolbel Soft Tissue Retractor

Single-pronged, angled, 190mm



Code
TI-004637943

Kolbel Soft Tissue Retractor

Single-pronged, straight, very fine tips, 190mm

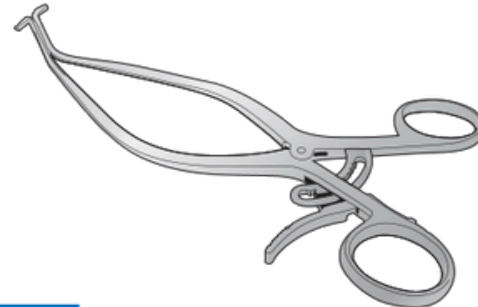

Code
TI-004636943

Kolbel Soft Tissue Retractor

Double pronged, angled, 190mm



Code
TI-004454965

Capsule Spreader

Single-pronged, fine, 90° curved, 165mm

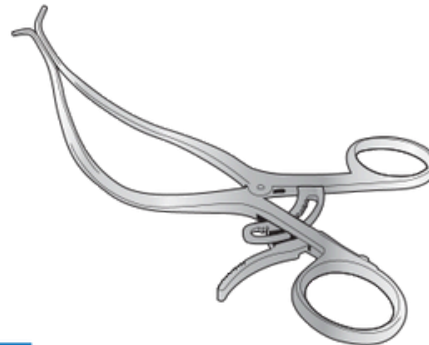

Code
TI-004455954

Fukuda-Kujat Humeral Head Retractor

35mm, wide blade, 225mm

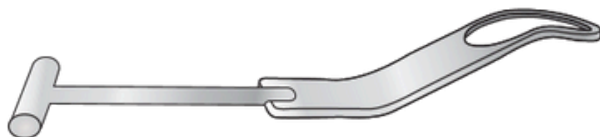

Code
TI-0046351113

Kolbel Self Retaining Glenoid Retractor

With ball snap-fit, slightly curved, 200mm

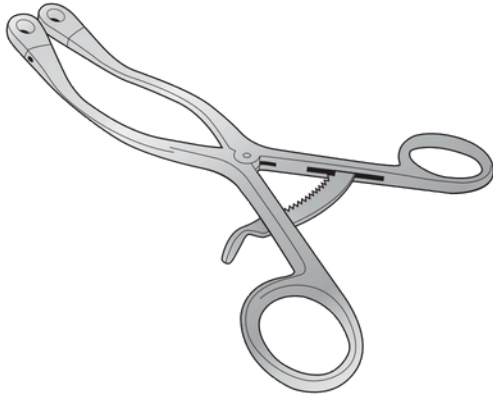

Code
TI-004459965

Kolbel Glenoid Retractor

Double-pronged, angled tips, 300mm, 18mm straight



Code
TI-004458416

Kolbel Glenoid Retractor

Double-pronged, angled tips, 300mm, 15mm strongly curved



Code
TI-004457V318416

Pair of Kolbel Self Retaining Glenoid Retractor Blades

With ball fit

EACH Blade

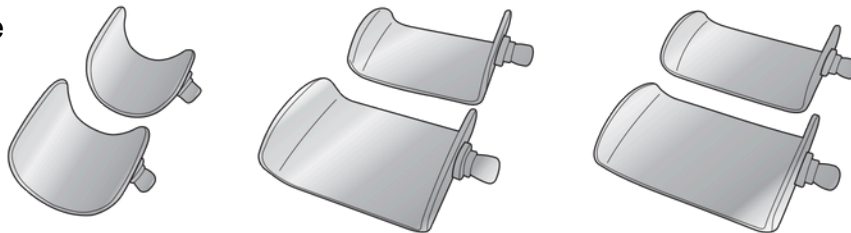

Code	TI-	DeTcription	Pair of blades
004460954	TI-	size 36 x 36mm	Pair of blades
004461V316		size 53 x 36mm	Pair of blades
TI-004462V319		size 68 x 36mm	Pair of blades



STKR

INTERNATIONAL

Head Office: Lyndhurst, Ohio 44124, USA

 **+1 216-493-3612**

**Manufacturing & Production: Karcha road
Shahab Pura Rd, Sialkot, 51310, Punjab
Pakistan**

 **+92 3085787794**

Email: info@stkrurgical.com

Website: www.stkrurgical.com



ایران صنعت و تجارت سیاکوٹ